

VLF

Floor Scale and HAWK™ Terminal Installation and Service Manual

© Mettler-Toledo, Inc. 1999, 2001

No part of this manual may be reproduced or transmitted in any form or by any means, electronic or mechanical, including photocopying and recording, for any purpose without the express written permission of Mettler-Toledo, Inc.

U.S. Government Restricted Rights: This documentation is furnished with Restricted Rights.

METTLER TOLEDO

Publication Revision History

An overview of this manual's revision history is compiled below.

Publication Name: VLF Floor Scale and HAWK Terminal Installation and Service Manual

Publication Part Number: 15849100A

Publication Date: 11/99

Part Number	Date	Revisions
A15849100A	2/01	Updated for software version 2.00 of HAWK terminal. Added Appendix 3: ASCII Input Commands.

INTRODUCTION

This publication is provided solely as a guide for individuals who have received Technical Training in servicing the METTLER TOLEDO product.

Information about METTLER TOLEDO Technical Training can be obtained by writing, calling, or faxing:

METTLER TOLEDO

1900 Polaris Parkway
Columbus, Ohio 43240 USA
Phone: (614) 438-4511
Fax: (614) 438-4958
www.mt.com

FCC Notice

This device complies with Part 15 of the FCC Rules and the Radio Interference Requirements of the Canadian Department of Communications. Operation is subject to the following conditions: (1) this device may not cause harmful interference, and (2) this device must accept any interference received, including interference that may cause undesired operation.

This equipment has been tested and found to comply with the limits for a Class A digital device, pursuant to Part 15 of FCC Rules. These limits are designed to provide reasonable protection against harmful interference when the equipment is operated in a commercial environment. This equipment generates, uses, and can radiate radio frequency energy and, if not installed and used in accordance with the instruction manual, may cause harmful interference to radio communications. Operation of this equipment in a residential area is likely to cause harmful interference, in which case the user will be required to correct the interference at his own expense.

**METTLER TOLEDO RESERVES THE RIGHT TO MAKE REFINEMENTS OR
CHANGES WITHOUT NOTICE.**

Declaration of conformity
Konformitätserklärung
Déclaration de conformité
Declaración de Conformidad
Conformiteitsverklaring
Dichiarazione di conformità

We/Wir/Nous/Wij/Noi: **Mettler-Toledo, Inc.**
 1150 Dearborn Drive
 Worthington, Ohio 43085
 USA

declare under our sole responsibility that the product,
erklären, in alleiniger Verantwortung, daß dieses Produkt,
déclarons sous notre seule responsabilité que le produit,
declaramos, bajo nuestra sola responsabilidad, que el producto,
verklaren onder onze verantwoordelijkheid, dat het product,
dichiariamo sotto nostra unica responsabilità, che il prodotto,

Type: Analog Load Cell

Model: 713

to which this declaration relates is in conformity with the following standard(s) or other normative document(s).

auf das sich diese Erklärung bezieht, mitder/den folgenden Norm(en) oder Richtlinie(n) übereinstimmt.
Auquel se réfère cette déclaration est conforme à la (aux) norme(s) ou au(x) document(s) normatif(s).
Al que se refiere esta declaración es conforme a la(s) norma(s) u otro(s) documento(s) normativo(s).
Waarnaar deze verklaring verwijst, aan de volende norm(en) of richtlijn(en) beantwoordt.
A cui si riferisce questa dichiarazione è conforme alla/e sequente/i norma/e o documento/i normativo/i.

CE Conformity / CE-Konformität / Conformité CE

90/384/EU Nonautomatic Balances and Scales / Nichteselbsttätige Waagen / Balances à Fonctionnement non automatique
Article 1.2.b.

Other Directives and Standards / Andere Richtlinien und Normen / Autres documents

corresponding to local requirements / entsprechend lokalen Anforderungen / correspondant aux exigences locales

Darrell Flocken, Manager - Weights & Measures
Office of Weights and Measures
Worthington, Ohio USA
June, 1999

according to EN45014

PROPRIETARY NOTICE

The information contained in this publication is derived in part from proprietary and patented data of METTLER TOLEDO. This publication shall not be copied in whole or in part without prior written approval of METTLER TOLEDO, nor shall it be used for any purpose other than that intended. This document is subject to change without notice.

STANDARD WARRANTY

METTLER TOLEDO warrants that the equipment covered by this warranty will be free from defects in workmanship and material for one year from date of installation or eighteen (18) months from date of shipment to the buyer, whichever comes first.

Should any such defects be found and reported during the first thirty (30) days after installation (if installation occurs during the warranty period), METTLER TOLEDO (herein referred to as the "Company") will, at its option, refund the purchase price or correct such defects, furnishing replacement parts and service free of charge to the buyer. For the remainder of the first 12 months of the warranty term, the Company will furnish necessary replacement parts and on-site technician's service free of charge, provided the Buyer agrees to pay reasonable technician's travel time, vehicle mileage, and associated travel expenses to and from the nearest authorized Company service location. If the equipment is covered by a two-year warranty, for the last 12 months or remaining balance of the warranty period, whichever comes first, the Company will furnish the necessary replacement parts to the Buyer free of charge, provided that the Buyer agrees to pay reasonable technician's on-site labor services, travel time, mileage, and expenses to and from the nearest authorized Company service location. The following are NOT covered under any of these warranties:

1. Initial installation and ongoing scale calibration.
2. Damage to scale components by gross abuse, fire, flooding, explosion, water, voltage surges, or civil disturbance.
3. Normal maintenance or consumable items.

This warranty covers only the VLF floor scale. Refer to METTLER TOLEDO Standard Product Warranty for coverage of other scale system components, including scale instrument, printer, and/or other accessories.

THE COMPANY EXPRESSLY WARRANTS THE EQUIPMENT MANUFACTURED BY IT AS SET FORTH HEREIN. THE COMPANY MAKES NO OTHER WARRANTIES EITHER EXPRESSED OR IMPLIED (INCLUDING WITHOUT LIMITATION WARRANTIES AS TO MERCHANTABILITY OR FITNESS FOR A PARTICULAR PURPOSE). IN ADDITION, THIS DOCUMENT SHALL CONSTITUTE THE SOLE AND EXCLUSIVE REMEDIES OF THE BUYER FOR ANY BREACH BY THE COMPANY OF ITS WARRANTIES HEREIN.

COMPANY LIABILITY UNDER THIS WARRANTY OR ANOTHER WARRANTY, WHETHER EXPRESSED OR IMPLIED IN LAW OR FACT, SHALL BE LIMITED TO THE REPAIR OR REPLACEMENT OF DEFECTIVE MATERIAL AND WORKMANSHIP, AND IN NO EVENT SHALL IT BE LIABLE FOR CONSEQUENTIAL OR INDIRECT DAMAGES.

This warranty coverage is applicable only to the United States of America.

Export Products: The Company warrants equipment destined for export or sold for export to be free from defects in workmanship and material for a period of one year from date of installation or 18 months from date of shipment to the Buyer, whichever occurs first. Should any such defect be found within that period, parts will be furnished free of charge (ex works) point of origin or final distribution center. If the Buyer requests the performance of warranty work provided for under the foregoing warranty outside of the contiguous United States, the Buyer shall be required to pay for labor, travel time, living, and travel expenses of any personnel required to perform such warranty work.

APPLICATION GUIDES

The only warranty of METTLER TOLEDO is for the product it supplies under the Product Warranty Statement listed above. Weighing application guidelines pertain to METTLER TOLEDO products.

Precautions

READ this manual BEFORE operating or servicing this equipment.

FOLLOW these instructions carefully.

SAVE this manual for future reference.

DO NOT allow untrained personnel to operate, clean, inspect, maintain, service, or tamper with this equipment.

ALWAYS DISCONNECT this equipment from the power source before cleaning or performing maintenance.

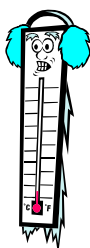

CALL METTLER TOLEDO for parts, information, and service.



Note: If the unit has been stored or transported in below freezing temperatures, allow the unit to warm up to room temperature before turning on AC power.

	 WARNING
	DISCONNECT ALL POWER TO THIS UNIT BEFORE INSTALLING, SERVICING, CLEANING, OR REMOVING THE FUSE. FAILURE TO DO SO COULD RESULT IN BODILY HARM AND/OR PROPERTY DAMAGE.

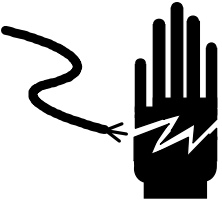
	 CAUTION
	OBSERVE PRECAUTIONS FOR HANDLING ELECTROSTATIC SENSITIVE DEVICES.

	 WARNING
	PERMIT ONLY QUALIFIED PERSONNEL TO SERVICE THIS EQUIPMENT. EXERCISE CARE WHEN MAKING CHECKS, TESTS, AND ADJUSTMENTS THAT MUST BE MADE WITH POWER ON. FAILING TO OBSERVE THESE PRECAUTIONS CAN RESULT IN BODILY HARM.

	 WARNING
	FOR CONTINUED PROTECTION AGAINST SHOCK HAZARD, CONNECT TO PROPERLY GROUNDED OUTLET ONLY. DO NOT REMOVE THE GROUND PRONG.

 CAUTION
BEFORE CONNECTING OR DISCONNECTING ANY INTERNAL ELECTRONIC COMPONENTS OR INTERCONNECTING WIRING BETWEEN ELECTRONIC EQUIPMENT, ALWAYS REMOVE POWER AND WAIT AT LEAST THIRTY (30) SECONDS. FAILURE TO OBSERVE THESE PRECAUTIONS COULD RESULT IN BODILY HARM OR DAMAGE TO OR DESTRUCTION OF THE EQUIPMENT.

CONTENTS

1 Introduction	1-1
HAWK Terminal Specifications	1-2
VLF Floor Scale Specifications	1-2
Load Cell Specifications	1-3
Load Cell Approvals	1-3
2 Installation	2-1
Unpacking and Inspection	2-1
Level the Base	2-2
Connect the Terminal	2-3
Powerup Sequence	2-3
Serial Port Connections	2-4
3 Programming and Calibration	3-1
Key Functions	3-1
Entering the Programming Mode	3-2
Program Blocks	3-3
Factory Default Settings	3-4
F1 Scale Block	3-5
F2 Application Block	3-7
F3 Interface Block	3-9
Exit Sub-Block	3-10
Sealing the Enclosure (Legal for Trade)	3-10
4 Routine Care and Maintenance	4-1
General	4-1
Cleaning	4-1
Platform Inspection	4-2
Shift Adjustment	4-2
5 Troubleshooting	5-1
General	5-1
Error Codes	5-2
Isolate the Problem	5-3
Check Wiring	5-3
Check Load Cells	5-4
Check Mechanical Components	5-4
Check Terminal Voltages	5-5
Parts Replacement	5-6
6 Parts and Accessories	6-1
VLF Floor Scale	6-2
7 Appendices	7-1
Appendix 1: Demand Mode Output	7-1
Appendix 2: Continuous Mode Output	7-4

Appendix 3: ASCII Input Commands.....	7-6
Appendix 4: GEO Codes.....	7-7

1

Introduction

The VLF floor scale is a low-profile scale base for top-of-floor applications. When packaged with a HAWK™ terminal, this fully electronic scale is calibrated at the factory so that it is ready to use right out of the box.

VLF floor scales are designed for general purpose weighing in dry industrial and commercial environments such as shipping docks. They should not be used in environments requiring washdown, immersion in liquids, exposure to splashing liquids, or exposure to corrosive chemicals.

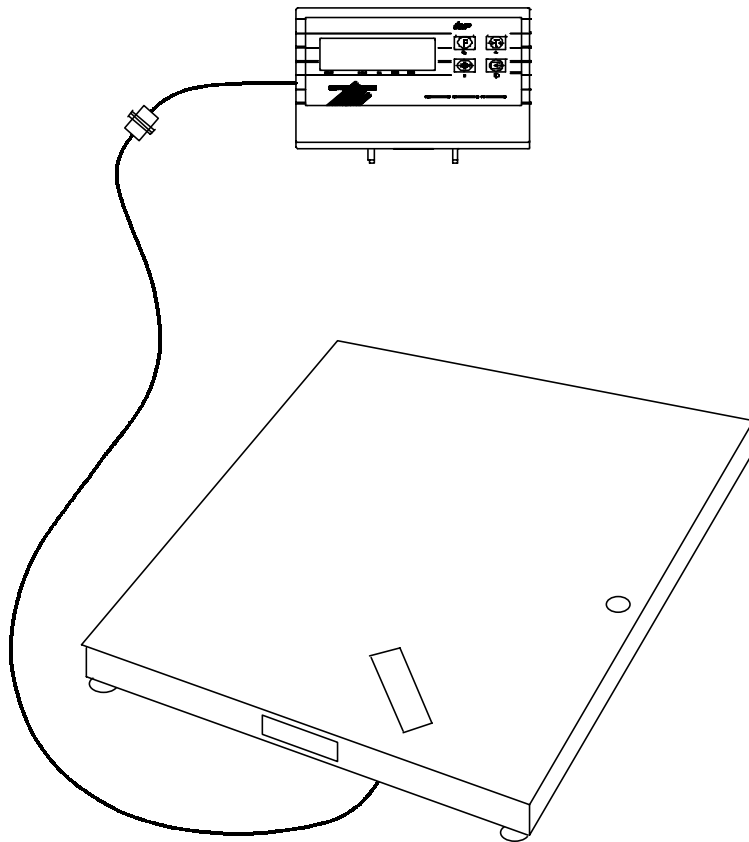

Figure 1-1: VLF Floor Scale and HAWK Terminal

This manual explains how to install, program, and service a VLF floor scale and HAWK™ terminal. If any information in the manual is incorrect or missing, please use the Publication Suggestion Report at the back of the manual to tell us about it.

HAWK Terminal Specifications

Displayed Resolution	Up to 10,000d
Dimensions (W x D x H)	10.2 x 6.2 x 5.6 inches (260 x 160 x 145 mm)
Construction	ABS plastic
Power	10.2 VDC / 0.15 A (AC transformer included) or six size-D batteries
Display	LCD, six digits: 1 inch (25 mm) high
Keypad	Four color-coded, tactile-feel keys: ZERO, TARE, FUNCTION, and PRINT
Operating Temperature	14°F to 104°F (-10°C to 40°C) with 10 to 95% relative humidity, noncondensing
Storage Temperature	-4°F to 140°F (-20°C to 60°C)) with 10 to 95% relative humidity, noncondensing
Data Output	ASCII via RS-232 standard
Weighing Units	Pounds, kilograms, and grams
Approvals	UL Listed Canada Weights and Measures AM-5318 US Weights and Measures CoC #99-054

VLF Floor Scale Specifications

Maximum Capacity	5,000 lb (2,500 kg)
Standard Division Size	1.0 lb (0.5 kg)
Platform Size	4 x 4 feet (1,219 x 1,219 mm)
Minimum Height	3.5 inches (89 mm)
Construction	Steel channel, uninitized
Operating Temperature	48°F to 104°F (10°C to 40°C)
Junction Box	Top access, NEMA 4X
Home Run Cable Length	25 feet (7.6 m)
Shipping Weight	375 lb (170 kg)

Load Cell Specifications

Model Number	713
Capacity	2,500 lb
Rated Output	3 mV/V
Excitation Voltage	15 VDC maximum
Sealing	Environmentally protected (potted)
Material	17-4 PH stainless steel
Cable Length	8 feet (2.4 meters), four-conductor cables
Input Terminal Resistance	350 ohms
Output Terminal Resistance	350 ± 3 ohms
Temperature Range (compensated)	14°F to 104°F (-10°C to 40°C)
Safe Overload	150% Rated Capacity (RC)
Safe Side Overload	150% RC
Combined Error (linearity and hysteresis)	0.04% RC
Nonrepeatability	0.01% RC
Creep in 20 minutes	0.03% RC
Zero Balance	2.0% RC

Load Cell Approvals

NTEP Certification

NIST H-44 Class III 5,000d multiple cell.

Hazardous Area Approval

Model 713 load cells are FM approved for hazardous areas.

2

Installation

Unpacking and Inspection

When you receive the scale, inspect it to make sure that it is not damaged and that all parts are included:

1. If the shipping skid shows signs of damage when delivered, file a freight claim with the carrier if necessary.
2. Remove the scale base from the shipping skid.

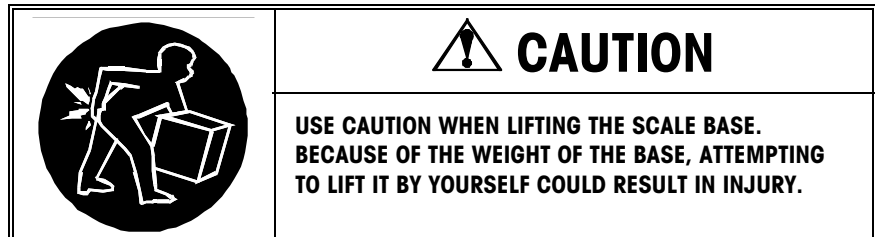

3. Remove the protective covering. Store the packaging and skid to use if you need to transport or ship the scale later.
4. Inspect the scale base and terminal for damage. Never install a scale if damage is apparent.
5. Make sure all components are included:
 - VLF Floor Scale
 - VLF Operator Card
 - HAWK Terminal (optional)
 - HAWK Technical Manual (optional)
6. Contact your authorized METTLER TOLEDO representative if the scale is damaged or any parts are missing.

Level the Base

Set up the scale base on a firm, level, and vibration-free surface. Once the scale base is in place, make sure it is level. Each of the four leveling feet should touch the floor. The scale base should not rock or teeter.

- Use a screwdriver to adjust the leveling feet as needed. Adjustments can be made from the top of the scale platform at the access holes located in the corners of the platform (see Figure 2-1).

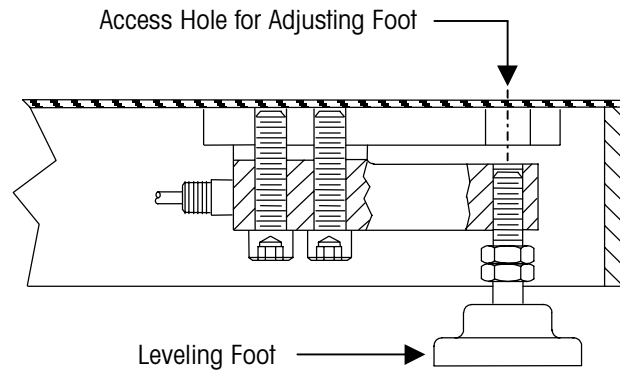

Figure 2-1: Leveling Foot

- Check the level that is located on the top of the scale base. Adjust the leveling feet until the bubble on the level is centered (see Figure 2-2).

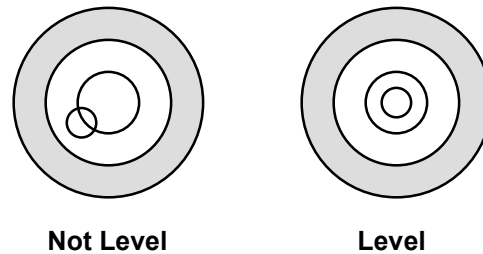

Figure 2-2: Leveling the Scale Base

- You must re-level the scale base every time you move it to a new location.

Connect the Terminal

Place the HAWK terminal on a desk or mount it to a wall (an optional wall-mount bracket is available). Connect the 25-foot cable from the VLF floor scale to the 12-inch cable from the terminal. The cables are equipped with 9-pin connectors. Plug the connectors together and tighten the screws to secure the connection.

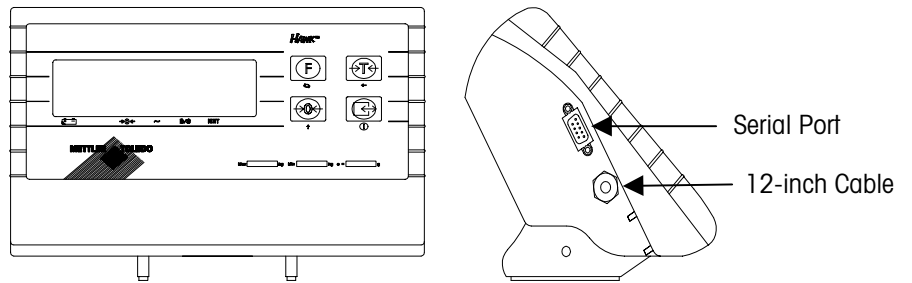

Figure 2-3: HAWK Terminal

Connect the terminal to the power source. Plug the round connector from the power transformer into the side of the HAWK terminal. Plug the power transformer into a 120V AC outlet. Press and hold the ON/OFF (PRINT) key for 3 seconds to turn on the terminal. Pressing the key again for 3 seconds will turn off the terminal.

Each scale is calibrated at the factory and should not need to be adjusted. Once the scale base and terminal are set up, check to make sure that they are working properly.

Place a test weight on the scale platform. The test weight should equal at least 20% of the rated capacity of the scale. The rated capacity of the VLF floor scale is 5,000 lb (2,500 kg).

Powerup Sequence

The HAWK terminal goes through a series of self-tests when it is turned on. These tests confirm normal internal operation. The powerup sequence is as follows:

While the display shows all numbers 0 to 9, a diagnostic self-test is performed on the memory and microprocessor. An error message is displayed if any component fails the test. The program number [125362] is shown next, followed by the revision [Sr. 2.00].

If the terminal passes all tests, the display will show [0.00]. The powerup sequence requires a few seconds to complete.

Serial Port Connections

The HAWK terminal provides a bi-directional RS-232 port as standard. This port can be used to send data to or receive commands from a computer, printer, or other serial device. Table 2-1 describes the pin configuration of the 9 pin D-Sub female connector on the side of the terminal. The maximum recommended cable length for RS-232 communications is 50 feet (15 meters).

Pin	Signal	Description
1		Not Connected
2	RxD	Receive Data
3	TxD	Transmit Data
4		Not Connected
5	Gnd	Logic Ground
6		Not Connected
7		Not Connected
8		Not Connected
9		Not Connected

Table 2-1: Serial Port Connection

Table 2-2 shows the ASCII commands that may be used to communicate with the HAWK terminal via the serial port. A more complete explanation is given in Appendix 3.

ASCII Command	Function Performed in the HAWK Terminal
C	Clear Tare
T	Tare
P	Print
Z	Zero

Table 2-2: ASCII Commands

3

Programming and Calibration

	<p style="text-align: center;"> WARNING</p> <p>PERMIT ONLY QUALIFIED PERSONNEL TO SERVICE THIS EQUIPMENT. EXERCISE CARE WHEN MAKING CHECKS, TESTS, AND ADJUSTMENTS THAT MUST BE MADE WITH POWER ON. FAILING TO OBSERVE THESE PRECAUTIONS CAN RESULT IN BODILY HARM.</p>
---	---

The scale is calibrated and programmed at the factory, so that it is ready to use right out of the box. You do not need to change any of the softswitch parameters or to calibrate the scale. However, for legal-for-trade commercial applications, the scale must be calibrated with certified test weights to the capacity and increment size shown on the data plate. All operational changes and calibration can be performed using the keys on the terminal.

Key Functions

You can use the keys on the HAWK terminal to reconfigure the scale. When the terminal is in programming mode, the keys have the following functions:



ZERO

Back up to the previous step.



TARE

Moves the data entry position one digit to the left.



FUNCTION

Increments the numeric data entry digit and/or allows the programmer to view the next display in a selection list.



PRINT

Accepts/terminates a data entry.



Entering the Programming Mode

The HAWK terminal has program blocks and sub-blocks that can be configured to determine how the scale will function. To access these blocks, open the terminal enclosure and place the CAL jumper in the ON position (shorting the two pins on the Controller PCB). See Figure 3-1 for the CAL jumper location.

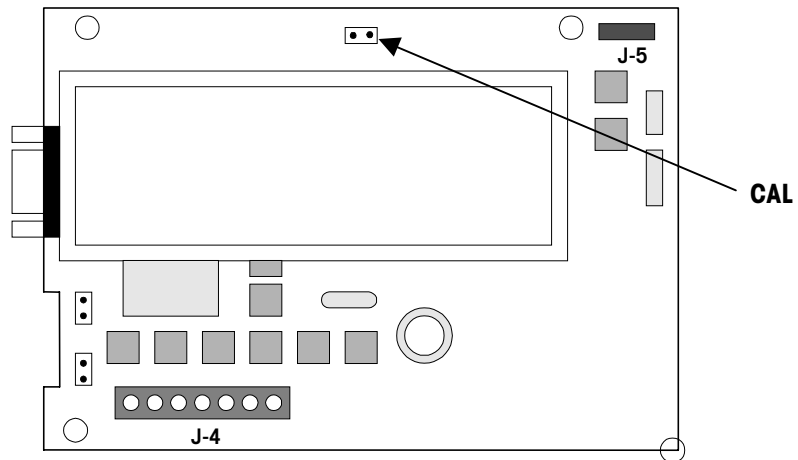

Figure 3-1: CAL Jumper Location

1. To configure the program blocks, you must enter the programming mode by pressing and releasing the PRINT and ZERO keys simultaneously.
2. When the **[F1]** prompt is displayed, use the PRINT key to enter the F1 program block. Use the FUNCTION key to skip to the next block. Use the ZERO key to go to the previous block.
3. Once the PRINT key is pressed, the HAWK terminal advances to the first parameter in the F1 program block. The display shows the sub-block number and the current value setting. Press the PRINT key to accept the value and advance to the next sub-block or press the FUNCTION key to toggle through the choices until the desired selection is displayed.
4. After the desired selection is displayed, press the PRINT key to accept the value. Continue this procedure throughout the setup routine until all required changes have been made.

Program Blocks

The HAWK terminal has a series of program blocks and sub-blocks that can be set to determine how the scale will function. These program blocks are shown in Figure 3-2.

There are three main blocks (F1, F2, and F3), each containing programming sub-blocks (F1.1, F1.2, and so on).

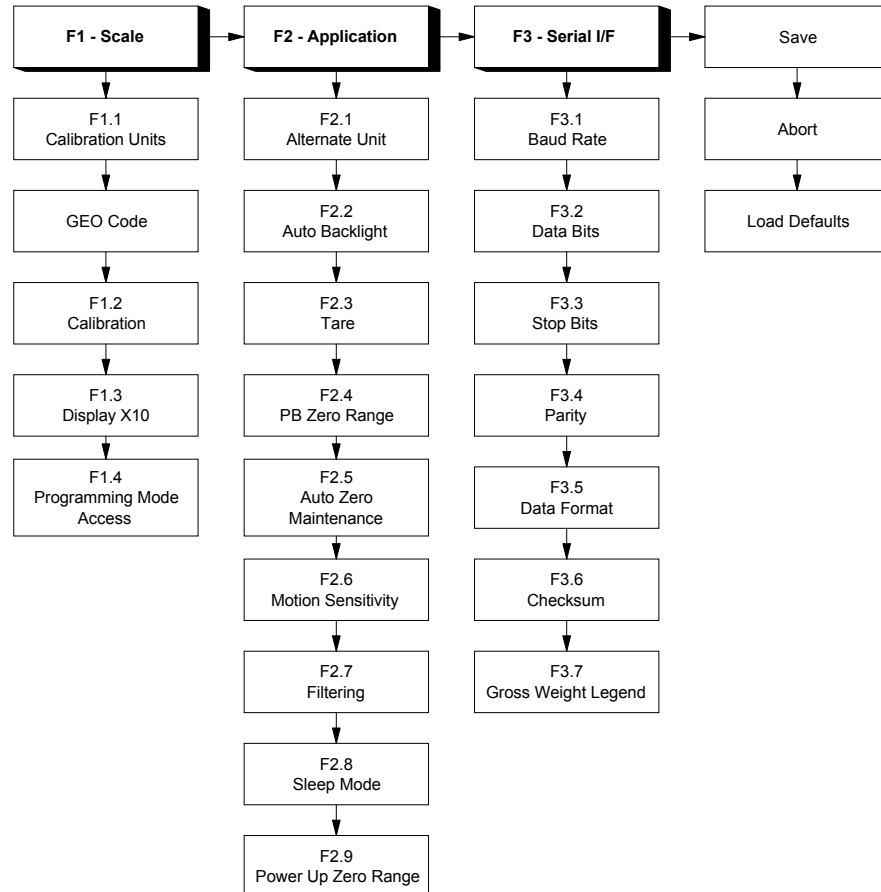

Figure 3-2: HAWK Terminal Program Blocks

Factory Default Settings

Table 3-1 lists the factory default setup parameters for the HAWK terminal.

STEP	DEFAULT	DESCRIPTION
F1.1	*	Calibration units – No default
GEO	*	Gravity adjust – No default
F1.2	0	Skip calibration
F1.3	0	Normal weight display
F1.4	0	Programming mode access disabled
F2.1	0	Alternative units = none (Unit switch disabled)
F2.2	0	Auto Backlight disable
F2.3	1	Tare enable
F2.4	1	Push button zero enabled, 2% range
F2.5	1	Auto zero maintenance enabled within 0.5d window
F2.6	1	Motion sensitivity $\pm 1d$
F2.7	0	No Filtering
F2.8	0	Sleep mode disable
F2.9	1	Auto zero capture at powerup range of $\pm 2\%$
F3.1	9600	Serial output baud rate
F3.2	7	Data bits
F3.3	2	Stop bits
F3.4	2	Even parity
F3.5	2	Print format = single line gross-tare-net
F3.6	1	Checksum enable
F3.7	0	No printed legend for gross weight field

Table 3-1: HAWK Terminal Default Settings

F1 Scale Block

The Scale Interface program block allows the user to set and calibrate the features that affect weighing performance.

[F1.1 2] CALIBRATION UNITS

Enter the number that corresponds to the type of test weights that will be used for calibration.

1 = lb

2 = kg

3 = g

[GEO 12] GRAVITY ADJUST

The HAWK terminal can compensate for variations caused by gravitational forces. It is calibrated with a GEO code of 12 at the factory. If the scale is subjected to a different gravitational force at its destination location, that can be compensated for electronically by adjusting the GEO code. There are 32 GEO code settings. The GEO code for any world location can be found in the GEO code table in Appendix 4 as long as the geographical coordinates and elevation above sea level are known. To change this setting, enter a new GEO code and the calibration will automatically be adjusted for your specific location.

[F1.2 0] SCALE CALIBRATION

0 = Skip calibration and proceed to F1.3

1 = Enter into the Calibration sub-block.

[CAP.] SCALE CAPACITY

[CAP.] is displayed briefly, and then the current scale capacity is shown. If you want to change the capacity, press the FUNCTION key to clear the data, and then enter new data.

METTLER TOLEDO VLF Floor Scale and HAWK Terminal Installation and Service Manual

Table 3-2 shows all possible selections for capacity and increment size.

Increment Size	Scale Capacity (lb, kg or g)											
	1	-	-	2	-	3	4	5	6	-	8	10
0.001	1	-	-	2	-	3	4	5	6	-	8	10
0.002	2	-	3	4	5	6	8	10	12	15	16	20
0.005	5	6	-	10	-	15	20	25	30	-	40	50
0.01	10	12	15	20	25	30	40	50	60	-	80	100
0.02	20	24	30	40	50	60	80	100	120	150	160	200
0.05	50	60	-	100	-	150	200	250	300	-	400	500
0.1	100	120	150	200	250	300	400	500	600	-	800	1000
0.2	200	240	300	400	500	600	800	1000	1200	1500	1600	2000
0.5	500	600	-	1000	-	1500	2000	2500	3000	-	4000	5000
1	1000	1200	1500	2000	2500	3000	4000	5000	6000	-	8000	10000
2	2000	2400	3000	4000	5000	6000	8000	10000	12000	15000	16000	20000
5	5000	6000	-	10000	-	15000	20000	25000	30000	-	40000	50000

Table 3-2: Capacity and Increment Size

[Incr.] INCREMENT SIZE

[Incr.] is displayed briefly, and then the current increment size is displayed for editing. Press the FUNCTION key to toggle through valid selections.

[E SCAL] Empty the scale platform and press the PRINT key to continue.

[15 CAL] Delay while initial is set (display counts down). If motion sensitivity is not disabled and motion is detected at this step, the display will show **[E 30]**. Press the PRINT key to return to the **[E SCAL]** prompt.

[Add Ld] Place test weight on the scale platform. Press the PRINT key.

[0000*0'] Enter the test weight value. No decimal point is permitted. Maximum test weight is 100% of full scale capacity. Minimum is 20% of full scale capacity.

[15 CAL] Delay while span is set (display counts down). If motion is detected at this step, then the display will show **[E 30]**. Press the PRINT key to return to the **[Add Ld]** prompt.

[CAL d] **[CAL d]** is displayed briefly to indicate that calibration is done.

[F1.3 0] EXPANDED DISPLAY

0 = Normal display mode

1 = Weight displayed in minors

[F1.4 0] PROGRAMMING MODE ACCESS

If CAL jumper is installed on the Controller PCB, this step has no effect, and the programming mode is always accessible.

If CAL jumper is not installed on the Controller PCB:

0 = No access to view or change values in the programming mode.

1 = Programming blocks F2 and F3 may be accessed to change the parameters. Programming block F1 may only be viewed.

F2 Application Block

[F2.1 0] ALTERNATE UNITS

Select the unit of measure desired as a secondary unit.

0 = No unit switching

1 = lb

2 = kg

If the calibration unit is "kg," the only choice is "lb."

If the calibration unit is "lb" or "g," the only choice is "kg."

If unit switching is enabled, a quick press of the FUNCTION key will change the unit.

[F2.2 0] AUTO BACKLIGHT

0 = Backlight can only be turned on manually by pressing the FUNCTION key.

1 = The backlight turns on during motion and stays on for 6 seconds after no-motion.

The manual on/off is always available. If unit switching is enabled, press and hold the FUNCTION key for 3 seconds to turn the back light on. If unit switching is disabled, a quick press of the FUNCTION key will turn the backlight on and off.

[F2.3 1] TARE

0 = Tare disabled

1 = Tare enabled

[F2.4 1] PUSHBUTTON ZERO RANGE

0 = Pushbutton zero disabled

1 = Enable pushbutton zero (within $\pm 2\%$ of scale capacity)

2 = Enable pushbutton zero (within $\pm 20\%$ of scale capacity)

[F2.5 1] AUTO ZERO MAINTENANCE

Auto Zero Maintenance (AZM) automatically compensates for small changes in zero resulting from material build-up or temperature changes. Select the weight range (\pm) around gross zero within which the scale will capture zero. If residual weight on the scale exceeds the weight range, the scale will not capture zero. AZM is disabled in the net mode.

0 = No AZM

1 = AZM within 0.5d window

2 = AZM within 1d window

3 = AZM within 3d window

[F2.6 1] MOTION SENSITIVITY SELECTION

The motion detection feature determines when there is no motion on the scale platform. The sensitivity level determines what is considered stable. Printing, pushbutton zero, and tare entry commands will not be carried out until the scale is stable.

0 = Motion detector disabled

1 = 1.0d motion sensitivity

2 = 3.0d motion sensitivity

[F2.7 0] FILTER

This function compensates for environmental disturbances such as vibration or noise.

0 = None

1 = Light

2 = Normal

3 = Heavy

[F2.8 0] SLEEP MODE (Power Saving)

0 = Disable

1 = Enable the sleep mode automatically after 5 minutes of stability

[F2.9 1] POWERUP ZERO RANGE

0 = Auto Zero capture at powerup disabled

1 = Auto Zero capture at powerup range of \pm 2%

2 = Auto Zero capture at powerup range of \pm 10%

If powerup zero capture is disabled, the terminal will display weight after powerup. Otherwise, if weight is not in zero-capture range, the display shows [E E E] or [-E-E-E], until weight is within the capture range.

F3 Interface Block

The following section will introduce the detail steps of configuring the RS-232 output.

[F3.1] BAUD RATE

[9600] Choose a baud rate from a list of 1200, 2400, 4800, or 9600.

[F3.2 7] DATA BITS

7 = 7 data bits

8 = 8 data bits

[F3.3 2] STOP BITS

1 = 1 stop bit

2 = 2 stop bits

[F3.4 2] PARITY

0 = No parity

1 = Odd parity

2 = Even parity

[F3.5 2] DATA OUTPUT FORMAT

0 = Toledo Continuous with STX

1 = Demand, single line, displayed weight only

2 = Demand, single line, gross, tare, net

3 = Demand, three line, gross, tare, net

[F3.6 1] CHECKSUM (Only if F3.5 = 0)

0 = No checksum

1 = Checksum

[F3.7 0] PRINTED GROSS WEIGHT LEGEND

0 = No Legend

1 = B (bruto)

2 = G (gross)

Exit Sub-Block

At the end of the program blocks, there are three choices for exiting the programming mode: Save, Abort, and Default. Use the FUNCTION key to move from choice to choice. When the desired choice is displayed, press the PRINT key. The scale exits the programming mode after the selection.

- [SAVE]** Press the PRINT key to accept the changes that were made and exit the programming mode.
- [Abort]** Press the PRINT key to ignore any changes that were made and exit the programming mode.
- [dFAULT]** Press the PRINT key to reset all program block parameters to factory default and exit the programming mode. Parameters marked with an asterisk (*) in Table 3.1 will not be reset.

Sealing the Enclosure (Legal for Trade)

After calibration is complete, setup step F1.4 should be programmed as a "0" to eliminate accidental changes to the calibration values. After programming is complete, remove the setup jumper CAL (Figure 3-1) to prevent setup access. Close the enclosure, tightening all four screws on the rear cover. Install the two plastic plugs over the bottom screws and seal the enclosure as shown in Figure 3-3.

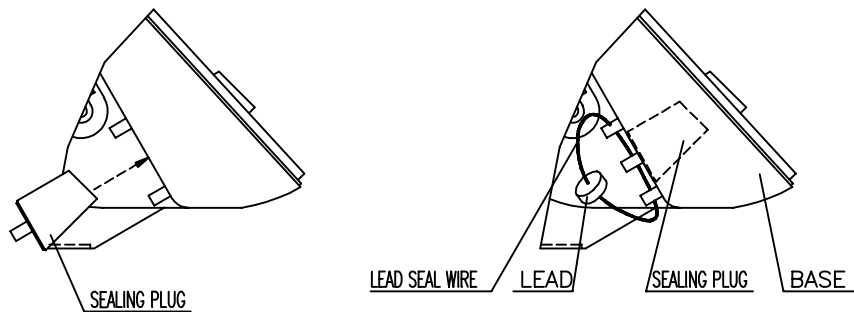

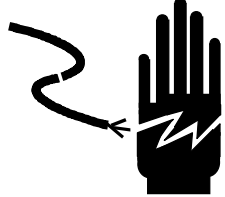

Figure 3-3: Sealing the Enclosure

4

Routine Care and Maintenance

General

Once the scale has been installed, an authorized METTLER TOLEDO representative should inspect and calibrate it periodically. If the scale is used for legal-for-trade purposes, consult the local Weights and Measures Authorities for minimum inspection requirements.

	 WARNING
	PERMIT ONLY QUALIFIED PERSONNEL TO SERVICE THIS EQUIPMENT. EXERCISE CARE WHEN MAKING CHECKS, TESTS, AND ADJUSTMENTS THAT MUST BE MADE WITH POWER ON. FAILING TO OBSERVE THESE PRECAUTIONS CAN RESULT IN BODILY HARM.

 CAUTION
BEFORE CONNECTING OR DISCONNECTING ANY INTERNAL ELECTRONIC COMPONENTS OR INTERCONNECTING WIRING BETWEEN ELECTRONIC EQUIPMENT, ALWAYS REMOVE POWER AND WAIT AT LEAST THIRTY (30) SECONDS. FAILURE TO OBSERVE THESE PRECAUTIONS COULD RESULT IN BODILY HARM OR DAMAGE TO OR DESTRUCTION OF THE EQUIPMENT.

Cleaning

Clean the terminal's cover and keyboard periodically with a soft, clean cloth that has been dampened with a mild window-type cleaner or detergent. DO NOT USE ANY TYPE OF INDUSTRIAL SOLVENT OR CHEMICALS. DO NOT SPRAY CLEANER DIRECTLY ONTO THE UNIT. DO NOT HOSE DOWN.

Platform Inspection

Inspect the scale assembly by checking the following:

- Are there any unusual wear points, paths, or marks on the weighing surface?
- Is the junction box cover on and are the load cell cables in good condition?
- Is there moisture or foreign material inside or around the junction box assembly?
- Is the instrument cable damaged or binding the scale?
- Has any debris or material built up under or around the platform that could inhibit freedom of movement?
- Visually inspect the load cells and leveling feet for signs of unusual wear.
- Check the repeatability and shift of the scale. Perform a shift adjustment if needed.

Shift Adjustment

When you shift adjust a scale, you are adjusting the output voltage (signal) of each load cell so that all load cells in the system produce a consistent signal. A correctly adjusted scale will give the same weight reading no matter where on the platform you place a test weight. Each VLF floor scale is shift adjusted at the factory. Normally, the only adjustment that might be needed is minor load cell trimming.

Make sure that the scale's mechanical parts are working properly. Then check the scale's repeatability by placing a test weight on the same location on the platform several times to make sure that you get the same weight reading each time. After checking for repeatability, adjust the load cell trimming potentiometers as needed.

Load Cell Trimming

Use the following procedure to trim the load cells:

1. Remove the access plate from the scale platform, and open the junction box. There are four trim potentiometers on the junction box PCB, one for each load cell (see Figure 4-1).

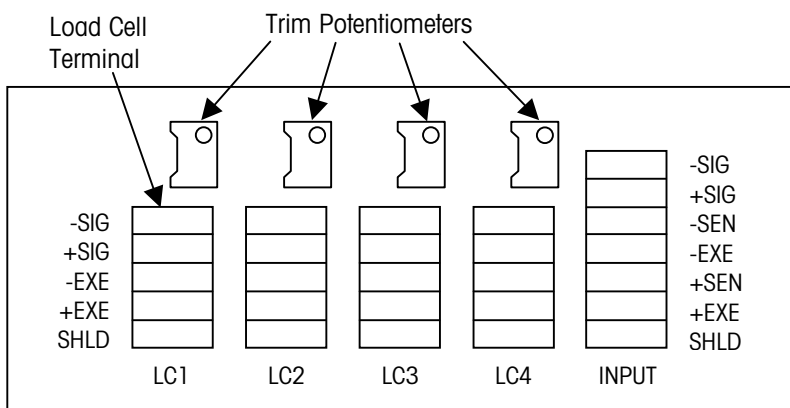

Figure 4-1: Junction Box PCB

Chapter 4: Routine Care and Maintenance
Shift Adjustment

- Figure 4-2 shows test weight locations (A, B, C, and D) at the center of each quadrant of the scale platform. Place a test weight (equal to half the rated scale capacity) at location A and record the weight reading. Then move the test weight to location B and record the weight reading. Continue until you have taken a weight reading at each of the four locations.

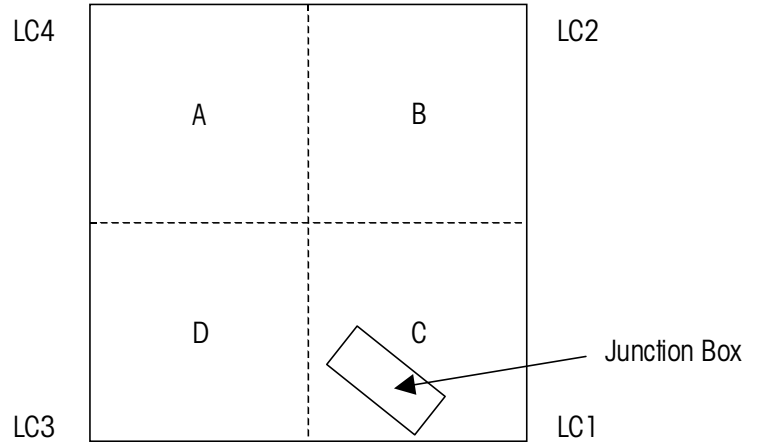

Figure 4-2: Test Weight Locations

- Place the test weight at the location immediately clockwise from the location at which you got the lowest weight reading. Then adjust the trimming potentiometer for the load cell that corresponds to the corner of the scale where the test weight is positioned (see Figure 4-2). Make the adjustment by turning the potentiometer until the weight reading matches the lowest reading.
- Proceeding clockwise, repeat the adjustment described in Step 3 for the next two test weight locations.

NOTE: Because the trimming potentiometers interact with one another, any adjustment will affect the weight readings at all four corners of the scale.

- Repeat Steps 2 to 4 until the weight readings at all corners of the platform are the same or are within the specified National Institute of Standards and Technology (NIST) Handbook 44 Scale Accuracy Requirements.
- Replace the junction box lid and platform access plate.

5

Troubleshooting



General

If the scale does not operate properly, find out as much about the problem as possible. Determine whether the problem is constant or intermittent. Be aware that problems can be caused by mechanical or electrical influences.

When troubleshooting a VLF scale, check for the following:

- Water
- Corrosive materials
- Unlevel floor
- Strong vibrations or wind currents
- Physical damage to the scale platform or frame

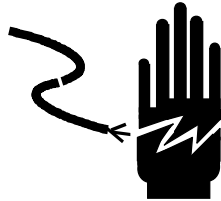
Check the instrument cable for damage, and check all connections for any loose or incorrect wiring.

	 WARNING
	PERMIT ONLY QUALIFIED PERSONNEL TO SERVICE THIS EQUIPMENT. EXERCISE CARE WHEN MAKING CHECKS, TESTS, AND ADJUSTMENTS THAT MUST BE MADE WITH POWER ON. FAILING TO OBSERVE THESE PRECAUTIONS CAN RESULT IN BODILY HARM.

 CAUTION
BEFORE CONNECTING OR DISCONNECTING ANY INTERNAL ELECTRONIC COMPONENTS OR INTERCONNECTING WIRING BETWEEN ELECTRONIC EQUIPMENT, ALWAYS REMOVE POWER AND WAIT AT LEAST THIRTY (30) SECONDS. FAILURE TO OBSERVE THESE PRECAUTIONS COULD RESULT IN BODILY HARM OR DAMAGE TO OR DESTRUCTION OF THE EQUIPMENT.

Error Codes

The following table lists the HAWK terminal's error messages.

Error Message	Description	Probable Action
E1	ROM error	Check Power Supply Voltages. Replace Controller PCB.
E2	Internal RAM error	Check Power Supply Voltages. Replace Controller PCB.
E7	EEPROM data incorrect	Check Power Supply Voltages. Replace Controller PCB.
E30	Scale in motion during calibration	Press PRINT to return to [E SCAL] or [ADD LD] .
E32	Insufficient calibration test weight or insufficient signal from load cell	Press PRINT, then add additional test weight. Recalibrate using more test weight.
E34	Calibration test weight too large	Press PRINT. Use test weight less than 100% of scale capacity.
EEE	Scale not zeroed at powerup	Auto Zero on powerup (F2.9) is enabled, and the weight is greater than zero. Zero the scale or remove the weight until zero is captured. Re-calibrate the scale.
-EEE	Scale not zeroed at powerup	Auto Zero on powerup (F2.9) is enabled, and there is not enough weight on the platform. Add weight until zero is captured. Re-calibrate the scale.
----	Overload indication	Weight on scale exceeds calibrated capacity by more than 9d. Decrease load on scale.
- - - -	Underload indication	Weight on scale is below gross zero by more than 9d. Increase load on scale.

Table 5-1: HAWK Terminal Error Codes

Isolate the Problem

Determine whether the problem is in the scale or the scale terminal.

1. Remove power from the system, and then disconnect the scale from the terminal.
2. Connect the terminal to a load cell simulator.
3. Reapply power and test the terminal.
4. If the problem goes away, its source is probably in the scale. Check the wiring, load cells, and mechanical components of the scale base.

If the problem persists, its source is probably in the terminal. Check the terminal's voltages.

Check Wiring

1. Remove power from the system.
2. Remove the access cover plate from the platform.
3. Open the junction box and check for moisture or foreign material inside the box.
4. Make sure that all wiring connections are tight and that no insulation material is touching the terminal contacts.
5. Make sure that all wires are connected to the correct terminals inside the junction box (refer to Table 5-2).

Load Cell Wiring		Instrument Cable Wiring*	
Function	Color	Function	Color
-Signal	White	-Signal	Black
+Signal	Green	+Signal	Green
-	-	-Sense	Red
-Excitation	Black	-Excitation	Blue
-	-	+Sense	Yellow
+Excitation	Red	+Excitation	White
Shield	Yellow	Shield	Orange
		*Based on METTLER TOLEDO Cable Number TA000137-025	

Table 5-2: Wiring Codes

6. Check all cable connectors on the junction box and tighten any loose connectors.

Check Load Cells

Check each load cell for proper bridge resistances (see Table 5-3).

Measuring Points	Resistance
+Exc (Red) to -Exc (Black)	350 ohms minimum
+Sig (Green) to -Sig (White)	347-353 ohms

Table 5-3: Bridge Resistances

1. Remove power from the system. Check each load cell for proper input/output resistances.
2. If resistance is within specification, perform a shorted-signal symmetry test.
 - Short the signal leads together and place one multimeter lead on the shorted signals and one lead on the +Excitation wire. Note the resistance value.
 - Remove the lead from the +Excitation wire and place it on the -Excitation wire. The two resistance values should be approximately equal.
3. If the load cells pass the shorted-signal test, reapply power to the scale. Confirm that proper excitation voltage is reaching the load cells by placing multimeter leads on the excitation positions of each load cell terminal.
4. If proper excitation voltage is reaching the load cells, check the output signal from each cell. If one cell has a particularly high or low dead-load output, it is suspect. The maximum output possible from any cell is 45 mV at 15 VDC excitation and loaded to gross capacity.
5. If any load cell has an unusual signal, remove all load from that cell.
 - With the power on, measure the output from the suspect load cell. The no-load zero output should be $\pm 2\%$ of the full scale output. For example, if the excitation voltage is 15 VDC, then the full scale output would be 45 mV and the no-load zero output should be within ± 0.9 mV.
6. If any load cell fails any of the above tests, replace it.

Check Mechanical Components

- Make sure the scale platform can move freely.
- Make sure the scale platform is level.
- Check the rocker pins for unusual wear. Replace any rocker pins that are unevenly worn or have flattened bearing surfaces.
- Inspect the platform for physical damage.

Check Terminal Voltages

If the problem is in the HAWK terminal, check the following voltages:

AC Power Test

Using a multimeter, check the AC input power. Input power must be within -15% and +10% of the nominal AC line voltage.

Controller PCB Input Voltage Test

Confirm that the AC adapter is outputting a voltage of at least 9 VDC. If the HAWK terminal has power and the Controller PCB does not function properly, replace the PCB.

Check Battery Voltage (Units with internal battery packs)

If the HAWK terminal does not respond when power is applied and the unit is turned on by pressing the PRINT key for approximately 3 seconds, the battery pack might be completely discharged. Install a new set of six size-D batteries and retest.

RS-232 Serial Output Test

Use the following test procedure to determine whether the RS-232 serial port is operational.

1. Remove power and disconnect the data cable from the HAWK terminal.
2. Set the volt meter to read 20 volts DC.
3. Connect the red lead to pin 3 of the HAWK serial port, and connect the black lead to pin 5.
4. Apply power. The meter should read as follows:
 - In Demand mode, the meter should read between -5 and -15 VDC with no fluctuation.

To test the Demand output, press the PRINT key on the HAWK terminal and the display should fluctuate between -5 volts and +5 volts for the duration of the transmission, then become stable again. This indicates that the terminal has transmitted data.

 - In Continuous mode, the meter should fluctuate between -5 and +5 VDC continuously. The constant fluctuation on the meter display indicates that the terminal is transmitting information.

J4 Terminal Strip Wiring

Figure 5-1 shows the functions for the J4 terminal strip inside the HAWK terminal, along with the wiring codes for a standard METTLER TOLEDO six-wire cable.

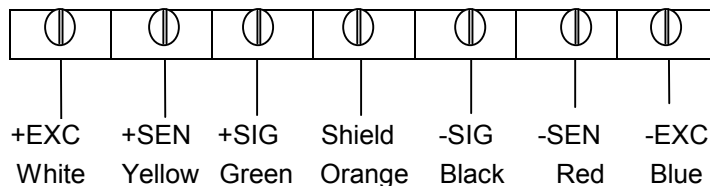

Figure 5-1: J4 Terminal Strip

Note that jumpers JUMP 1 and JUMP 2 on the Controller PCB should be OFF (not shorting the pins).

Parts Replacement

	 WARNING
	DISCONNECT ALL POWER TO THIS UNIT BEFORE INSTALLING, SERVICING, CLEANING, OR REMOVING THE FUSE. FAILURE TO DO SO COULD RESULT IN BODILY HARM AND/OR PROPERTY DAMAGE.

 CAUTION
BEFORE CONNECTING OR DISCONNECTING ANY INTERNAL ELECTRONIC COMPONENTS OR INTERCONNECTING WIRING BETWEEN ELECTRONIC EQUIPMENT, ALWAYS REMOVE POWER AND WAIT AT LEAST THIRTY (30) SECONDS. FAILURE TO OBSERVE THESE PRECAUTIONS COULD RESULT IN BODILY HARM OR DAMAGE TO OR DESTRUCTION OF THE EQUIPMENT.

Battery Replacement

The battery symbol at the lower left of the HAWK terminal display is used to indicate low battery power. The cursor above the battery symbol will light up when there is approximately 15 minutes of operation remaining.

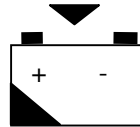

Figure 5-2: Battery Symbol

When the cursor above the battery symbol is lighted, change the batteries as soon as possible. To change the batteries:

1. Open the battery door on the rear of the HAWK terminal enclosure.
2. Remove the six batteries.

 CAUTION
THE HAWK TERMINAL CANNOT RECHARGE BATTERIES. IF RECHARGEABLE BATTERIES ARE USED, THEY MUST BE RECHARGED WITH A COMMERCIALY AVAILABLE RECHARGER AND THEN REINSTALLED IN THE TERMINAL.

3. Insert six new or recharged size-D batteries as illustrated on the battery housing (also shown in Figure 5-3).

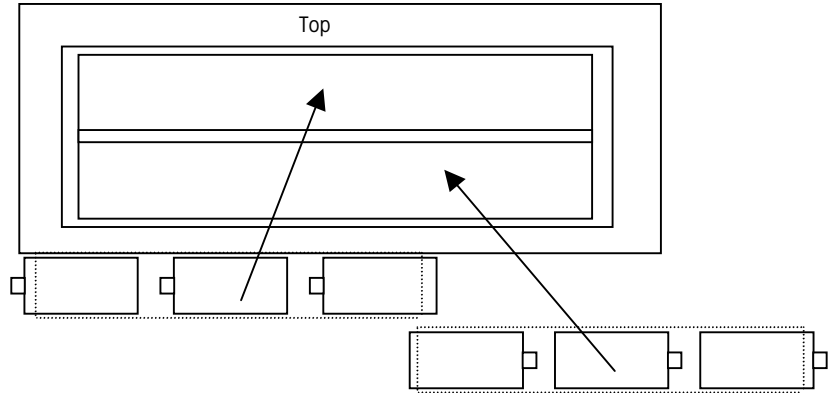

Figure 5-3: Shown With Rear Battery Panel Removed

4. Reinstall the rear cover over the batteries and press it into place.
5. Test for proper operation.

The operating time for a new set of size-D batteries depends on how the scale is used. Some estimates (without backlight) are shown below. Using the backlight feature reduces battery life.

Operation	Battery Life
Continuous use	400 hours (Approximately 17 days)
8 hours per day	500 hours (Approximately 3 months)

Table 5-4: Battery Life

Keyboard Replacement

1. Remove power by removing the six size-D batteries from the rear battery compartment and/or disconnecting the AC power adapter.
2. Remove the four screws securing the front and back halves of the cover.
3. Disconnect the keyboard tail from the Controller PCB and discard the old front cover.
4. Connect the keyboard tail of the new front cover to J5 of the Controller PCB.
5. Secure the front cover to the back cover with the four screws.
6. Apply power and then press and hold the ON/OFF (PRINT) key for 3 seconds.
7. Test the operation of the new keyboard.

Controller PCB Replacement

If the Controller PCB inside the HAWK terminal is faulty, use the following procedure to replace it.

	 WARNING
	DISCONNECT ALL POWER TO THIS UNIT BEFORE INSTALLING, SERVICING, CLEANING, OR REMOVING THE FUSE. FAILURE TO DO SO COULD RESULT IN BODILY HARM AND/OR PROPERTY DAMAGE.

 CAUTION
BEFORE CONNECTING OR DISCONNECTING ANY INTERNAL ELECTRONIC COMPONENTS OR INTERCONNECTING WIRING BETWEEN ELECTRONIC EQUIPMENT, ALWAYS REMOVE POWER AND WAIT AT LEAST THIRTY (30) SECONDS. FAILURE TO OBSERVE THESE PRECAUTIONS COULD RESULT IN BODILY HARM OR DAMAGE TO OR DESTRUCTION OF THE EQUIPMENT.

1. Remove power by removing the six size-D batteries from the rear battery compartment and/or disconnecting the AC power adapter.
2. Remove the four screws securing the front and back halves of the cover.
3. Disconnect the keyboard tail from the Controller PCB and set the front cover aside.
4. Disconnect the battery harness from the Controller PCB.
5. Disconnect the home run cable from the J4 terminal strip on the Controller PCB.
6. Remove the two hex standoffs from the side of the enclosure. These secure the serial output connector to the back cover of the HAWK terminal.
7. Remove the four screws that secure the Controller PCB to the back cover.
8. Using proper static electricity precautions, carefully remove the Controller PCB and place it in a protective static bag.
9. Install the new Controller PCB, using the four screws from the old PCB.
10. Install the two hex standoffs to the side of the enclosure, securing the serial output connector to the back cover of the HAWK terminal. Reconnect the home run cable to the J4 terminal strip.
11. Reconnect the AC adapter and battery harnesses.
12. Connect the keyboard tail of the front cover to J5 of the Controller PCB.
13. Secure the front cover to the back cover with the four screws.
14. Apply power to the HAWK terminal, and then press and hold the ON/OFF (PRINT) key for 3 seconds.
15. Reprogram, recalibrate, and test the operation of the new Controller PCB.

Load Cell Replacement

1. Remove power to the HAWK terminal and disconnect the instrument cable.
2. Remove the junction box cover and locate the defective load cell terminal.
3. Disconnect the defective load cell's cable from its terminal on the summing PCB.
4. Remove the load cell cable from the junction box enclosure.
5. Carefully position the platform on a stable supporting surface that allows access to the defective load cell and cable, as well as offering protection to the other cells during disassembly.
6. Tie a string to the end of the cable attached to the defective load cell. The string should be strong enough and long enough to pull the new load cell's cable through the platform structure.
7. The load cells are fastened to the platform using two 1/2-13 UNC socket head cap screws (see Figure 5-4). Remove the two load cell mounting screws with a 3/8-inch hex Allen socket wrench, retaining the screws for reinstallation. Lift the load cell and spacer plate from the mounting surface.

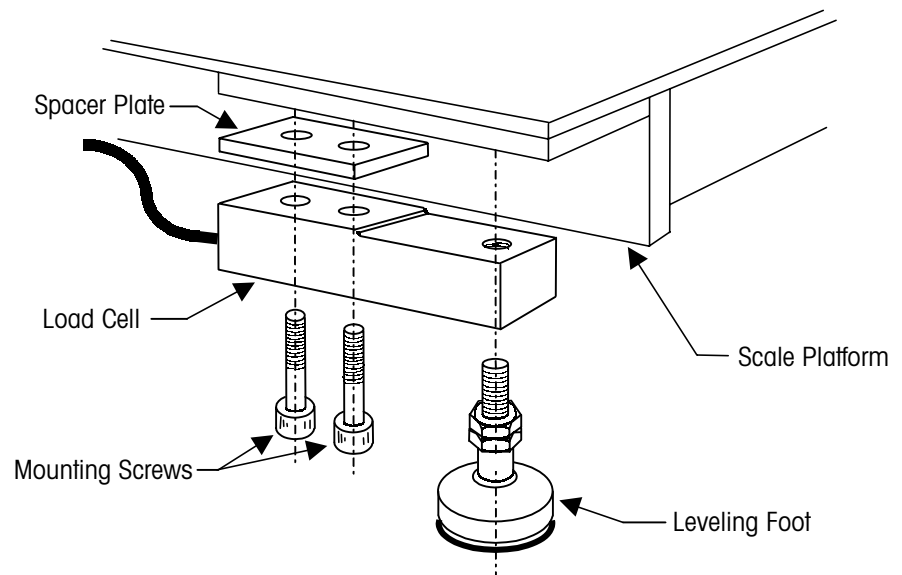

Figure 5-4: Load Cell Mounting

8. Carefully pull the defective load cell's cable through the platform while feeding the string in at the junction box opening. Once the string reaches the load cell mounting location, untie it from the load cell cable.
9. Remove the leveling foot from the defective load cell and reinstall it in the new load cell.
10. Tie the string to the new load cell's cable and carefully pull the new cable through the platform structure to the junction box opening. Coil any excess cable and store it within the platform.
11. Bolt the new load cell and spacer plate to the platform. Apply an anti-seize compound such as "Never-Seez" to the threads of the mounting screws and tighten them with a calibrated torque wrench to 100 ft-lb.
12. Thread the load cell cable through the connector on the junction box.

METTLER TOLEDO VLF Floor Scale and HAWK Terminal Installation and Service Manual

13. Wire the new load cell cable to the proper terminal on the PCB according to the load cell wiring code shown in Table 5-5.

Load Cell Wiring		Instrument Cable Wiring*	
Function	Color	Function	Color
-Signal	White	-Signal	Black
+Signal	Green	+Signal	Green
–	–	-Sense	Red
-Excitation	Black	-Excitation	Blue
–	–	+Sense	Yellow
+Excitation	Red	+Excitation	White
Shield	Yellow	Shield	Orange
		*Based on METTLER TOLEDO Cable Number TA000137-025	

Table 5-5: Wiring Codes

14. Level the scale with the leveling feet.
15. Reattach the instrument cable and power up the scale terminal. Perform a shift adjust and recalibrate the scale.

6

Parts and Accessories

Refer to the following pages when ordering parts for the VLF floor scale and HAWK terminal.

Item No.	Part Number	Description	Qty.
1	TB600833-008	Model 713 Load Cell, 2,500 lb	4
2	510624370	Terminal Cable	per foot
3	MZ0901010407	Screw, 10-32 x 0.18 inch long	4
4	MN31004	Data Label	1
5	TN100524	Screw, 10-32 x 0.62 inch long	2
6	TN201817	Circular Bubble Level	1
7	TN800733	Specification Label	1
8	TN203054	Junction Box Lid Assembly	1
9	TN600839	Load Cell Mounting Plate	4
10	TB100520	Junction Box Assembly (includes 14378800A PCB)	1
11	TN800736	VLF Label	2
12	TN800650	Load Cell Mounting Bolt, 1/2-13 x 2 inches long	8
13	10833900A	Cable Mounting Clamp	5
14	TN203980	Leveling Foot	4
15	MZ0904000067	Blind Rivet, 1/8 inch diameter	2
16	MZ0907000019	Ty Rap, 7.5 inches long	3

Table 6-1: VLF Floor Scale Parts

P/N	Description	Quantity
1274830TC	Main PCB with Backlight	1
1274840TC	Main PCB without Backlight	1
1274820TC	Front Cover, Keyboard & Overlay Assembly	1
1264310TC	Indicator Bracket Assembly	1
1244740TC	Wall Adapter, 120 VAC, US Plug	1
1259670TC	Wall Adapter, 220 VAC, US Plug	1
1259690TC	Wall Adapter, 230 VAC, EU Plug	1
1244530TC	Battery Cavity Cover Plate	1

Table 6-2: HAWK Terminal Parts

P/N	Description	Quantity
TE-00000	HAWK Terminal SS Wall-Mount Bracket	1
VLFA0100	Ramp, 4 x 4 feet, Painted Steel	1
VLFA0201	Foot Locating Plates	1

Table 6-3: Options

7 Appendices

Appendix 1: Demand Mode Output

Demand mode output occurs when a print request is received from the PRINT push button. The line format, baud rate, character length, and parity are selectable in the programming mode.

Demand mode output is prevented when the scale is "in motion" or when the weight is below 20d of gross weight or over capacity. When one of those situations occurs, the print request is ignored and is not stored. Zero must be captured at powerup before a demand mode output can occur. After one output, the scale must see motion before it will send data again.

Weight Field Format

Displayed Weight Format (Gross or Net)

Data	M	-	-	-	-	-	L	S	Units	S	B	C	L
	S						S	P		P		R	F
	D						D						
Note	3							4	5	4	2	6	8

Table 7-1: Gross Weight

Data	M	-	-	-	-	-	L	S	Units	S	N	C	L
	S						S	P		P		R	F
	D						D						
Note	9							4	5	4	10	6	8

Table 7-2: Net Weight

Single Line – Gross, Tare, Net Weights

Single-line gross weight format is output if no tare weight has been taken.

Data	M	-	-	-	-	-	L	S	Units	S	B	S	M	-	-	-	-	-	L	S	Units
	S						S	P		P		P	S						S	P	
	D						D					D							D		
Note	3						4	5	4	2	4	3						4	5		

Data	S	T	S	M	-	-	-	-	-	L	S	Units	S	N	C	L
	P		P	S						S	P		P		R	F
	D		D	D						D						
Note	4	10	4	9						4	5	4	10	6	8	

Table 7-3: Single Line – Gross, Tare, Net Weights

Multiple Line – Gross, Tare, Net Weights

If no tare weight has been taken, only the gross weight field is output.

Data	M	-	-	-	-	-	L	S	Units	S	B	C	L
	S						S	P		P		R	F
	D						D						
Note	3						4	5	4	2	6	8	

Table 7-4: Multiple Line – Gross Weight

Data	M	-	-	-	-	-	L	S	Units	S	T	C	L
	S						S	P		P		R	F
	D						D						
Note	11						4	5	4	10	6	8	

Table 7-5: Multiple Line – Tare Weight

Data	M S D	-	-	-	-	-	L S D	S P	Units	S P	N	C R	L F
Note	9							4	5	4	10	6	8

Table 7-6: Multiple Line – Net Weight

Demand Format Notes

- 2 Selectable gross weight legend. Selectable in the programming mode as a space, "B" for bruto or "G" for gross.
- 3 The gross weight data fields are padded with leading spaces to 7 digits.
- 4 ASCII Space <SP> character, hex value 20.
- 5 Weight units (lb, kg, g) as selected in setup and by the FUNCTION key.
- 6 ASCII Carriage Return <CR> character, hex value 0D.
- 7 Optional checksum character: Checksum is defined as the 2's complement of the seven low order bits of the binary sum of all characters preceding the checksum character, including the <STX> and <CR> characters. The checksum calculation for multiple lines of data includes the <LF> character from the previous line of data.
- 8 ASCII Line Feed <LF> character, hex value 0A.
- 9 The net weight field is right justified and padded with spaces to seven digits.
A negative net weight is indicated by a minus character before the most significant digit of the weight value. For example, a weight of -55.00 is printed with one leading space (s_p = space): s_p-55.00.
- 10 Weight field descriptors. The "TR" and "N" legends are printed (for net weight) after the tare and net weight fields to identify them.
- 11 The tare weight data field is padded with leading spaces to 7 digits.

Appendix 2: Continuous Mode Output

The continuous output format is output as the display is updated (approximately seven times per second). The format is fixed except for baud rate, data bits, stop bits, parity, and the selectable checksum character. The continuous output mode provides compatibility with METTLER TOLEDO products that require real-time weight data (for example, Model 8624, 9323, 9325, and other accessories).

Continuous data output at a 1200 baud rate will slow the display update rate. Use 4800 baud or faster to maintain the maximum update rate.

The continuous output includes status bytes that indicate the operating conditions in the terminal.

Character	1	Status			Indicated Weight						Tare Weight							
	2	3	4	5	6	7	8	9	10	11	12	13	14	15	16	17	1	
Data	S T X	S W A	S W B	S W C	M S D	-	-	-	-	L S D	M S D	-	-	-	-	L S D	C R	C H K
Note	1	2			3						4						5	6

Table 7-7: Continuous Format Output

Continuous Format Notes

- 1 ASCII Start of Text <STX> character, hex value 02.
- 2 SWA, SWB, and SWC: Status Words A, B, and C. Refer to Tables 7-8, 7-9, and 7-10 for status bytes.
- 3 Displayed weight: Six digits of displayed weight. No decimal point in field.
- 4 Tare weight: Six digits of tare weight data. No decimal point in field.
- 5 ASCII Carriage Return <CR> character, hex value 0D.
- 6 Optional checksum character: Checksum is defined as the 2's complement of the seven low order bits of the binary sum of all characters preceding the checksum character, including the <STX> and <CR> characters.

Status Byte Definition

The following tables detail the status bytes for the standard continuous output.

Bit Identification Table For Status Byte A				
Bit	Dummy Zero or Decimal Position			
	XXXX00	XXXXX0	XXXXXX	XXXXX.X
0	0	1	0	1
1	0	0	1	1
2	0	0	0	0
Bit	Dummy Zero or Decimal Position			
	XXXX.XX	XXX.XXX	XX.XXXX	X.XXXXX
0	0	1	0	1
1	0	0	1	1
2	1	1	1	1
Bit	Increment Size			
	X1	X2	X5	
3	1	0	1	
4	0	1	1	
5	Always = 1			
6	Always = 0			

Table 7-8: Status Byte A

Bit Identification Table For Status Byte B	
Bit	Function
0	Gross = 0, Net = 1
1	Sign, Positive = 0, Negative = 1
2	Out of Range = 1, In Range = 0
3	Motion = 1
4	lb = 0, kg = 1 (see also Byte C, bits 0, 1, 2)
5	Always = 1
6	Powerup Not Zeroed = 1

Table 7-9: Status Byte B

Bit Identification Table For Status Byte C	
Bit	Function
0	lb or kg = 0, grams = 1
1	Always = 0
2	Always = 0
3	Print Request = 1
4	Expand Weight Display = 1
5	Always = 1
6	Always = 0

Table 7-10: Status Byte C

Appendix 3: ASCII Input Commands

Beginning with software version 2.00, the HAWK terminal has the ability to receive certain ASCII characters via the serial port to perform simple keyboard functions. Previous versions of software did not have this capability. The software version can be viewed at powerup.

The ASCII input commands will operate when the serial port is programmed for either demand output or continuous output. The input character format must be the same as the data output format selected in setup, including baud rate, data bits, parity, and stop bits. The remote commands are subject to the same restrictions as the keyboard equivalents. For instance, tare, zero, and print commands will operate only if sent when there is no motion on the scale. When sending multiple commands, there must be a time delay of at least one-half second (500 milliseconds) between each remote ASCII command character.

These ASCII commands duplicate the front panel functions. Note that all characters are uppercase and no control characters such as <CR> (carriage return) or <LF> (line feed) need to be sent. If they are sent, they will be ignored. All ASCII characters other than the ones listed below will also be ignored.

The following commands are recognized by the HAWK terminal when the output mode is programmed as either demand mode or continuous output.

Command	Function	Description
C	Clear	Clear tare value
T	Tare	Performs a pushbutton tare
P	Print	Transmit data or set print bit in continuous output
S	Print	Transmit data or set print bit in continuous output
Z	Zero	Zero the scale (if within range and no-motion)

Appendix 4: GEO Codes

Use the following Geo Codes if you move the scale to a location other than the one where it was originally calibrated.

Northern and southern latitude in degrees and minutes	Height above sea-level in meters										
	0 325	325 650	650 975	975 1300	1300 1625	1625 1950	1950 2275	2275 2600	2600 2925	2925 3250	3250 3575
	Height above sea-level in feet										
	0 1060	1060 2130	2130 3200	3200 4260	4260 5330	5330 6400	6400 7460	7460 8530	8530 9600	9600 10660	10660 11730
0° 0' — 5° 46'	5	4	4	3	3	2	2	1	1	0	0
5° 46' — 9° 52'	5	5	4	4	3	3	2	2	1	1	0
9° 52' — 12° 44'	6	5	5	4	4	3	3	2	2	1	1
12° 44' — 15° 6'	6	6	5	5	4	4	3	3	2	2	1
15° 6' — 17° 10'	7	6	6	5	5	4	4	3	3	2	2
17° 10' — 19° 2'	7	7	6	6	5	5	4	4	3	3	2
19° 2' — 20° 45'	8	7	7	6	6	5	5	4	4	3	3
20° 45' — 22° 22'	8	8	7	7	6	6	5	5	4	4	3
22° 22' — 23° 54'	9	8	8	7	7	6	6	5	5	4	4
23° 54' — 25° 21'	9	9	8	8	7	7	6	6	5	5	4
25° 21' — 26° 45'	10	9	9	8	8	7	7	6	6	5	5
26° 45' — 28° 6'	10	10	9	9	8	8	7	7	6	6	5
28° 6' — 29° 25'	11	10	10	9	9	8	8	7	7	6	6
29° 25' — 30° 41'	11	11	10	10	9	9	8	8	7	7	6
30° 41' — 31° 56'	12	11	11	10	10	9	9	8	8	7	7
31° 56' — 33° 9'	12	12	11	11	10	10	9	9	8	8	7
33° 9' — 34° 21'	13	12	12	11	11	10	10	9	9	8	8
34° 21' — 35° 31'	13	13	12	12	11	11	10	10	9	9	8
35° 31' — 36° 41'	14	13	13	12	12	11	11	10	10	9	9
36° 41' — 37° 50'	14	14	13	13	12	12	11	11	10	10	9
37° 50' — 38° 58'	15	14	14	13	13	12	12	11	11	10	10
38° 58' — 40° 5'	15	15	14	14	13	13	12	12	11	11	10
40° 5' — 41° 12'	16	15	15	14	14	13	13	12	12	11	11
41° 12' — 42° 19'	16	16	15	15	14	14	13	13	12	12	11
42° 19' — 43° 26'	17	16	16	15	15	14	14	13	13	12	12
43° 26' — 44° 32'	17	17	16	16	15	15	14	14	13	13	12
44° 32' — 45° 38'	18	17	17	16	16	15	15	14	14	13	13
45° 38' — 46° 45'	18	18	17	17	16	16	15	15	14	14	13
46° 45' — 47° 51'	19	18	18	17	17	16	16	15	15	14	14
47° 51' — 48° 58'	19	19	18	18	17	17	16	16	15	15	14
48° 58' — 50° 6'	20	19	19	18	18	17	17	16	16	15	15
50° 6' — 51° 13'	20	20	19	19	18	18	17	17	16	16	15
51° 13' — 52° 22'	21	20	20	19	19	18	18	17	17	16	16
52° 22' — 53° 31'	21	21	20	20	19	19	18	18	17	17	16
53° 31' — 54° 41'	22	21	21	20	20	19	19	18	18	17	17
54° 41' — 55° 52'	22	22	21	21	20	20	19	19	18	18	17

METTLER TOLEDO VLF Floor Scale and HAWK Terminal Installation and Service Manual

Northern and southern latitude in degrees and minutes	Height above sea-level in meters										
	0 325	325 650	650 975	975 1300	1300 1625	1625 1950	1950 2275	2275 2600	2600 2925	2925 3250	3250 3575
	Height above sea-level in feet										
	0 1060	1060 2130	2130 3200	3200 4260	4260 5330	5330 6400	6400 7460	7460 8530	8530 9600	9600 10660	10660 11730
55° 52' — 57° 4'	23	22	22	21	21	20	20	19	19	18	18
57° 4' — 58° 17'	23	23	22	22	21	21	20	20	19	19	18
58° 17' — 59° 32'	24	23	23	22	22	21	21	20	20	19	19
59° 32' — 60° 49'	24	24	23	23	22	22	21	21	20	20	19
60° 49' — 62° 9'	25	24	24	23	23	22	22	21	21	20	20
62° 9' — 63° 30'	25	25	24	24	23	23	22	22	21	21	20
63° 30' — 64° 55'	26	25	25	24	24	23	23	22	22	21	21
64° 55' — 66° 24'	26	26	25	25	24	24	23	23	22	22	21
66° 24' — 67° 57'	27	26	26	25	25	24	24	23	23	22	22
67° 57' — 69° 35'	27	27	26	26	25	25	24	24	23	23	22
69° 35' — 71° 21'	28	27	27	26	26	25	25	24	24	23	23
71° 21' — 73° 16'	28	28	27	27	26	26	25	25	24	24	23
73° 16' — 75° 24'	29	28	28	27	27	26	26	25	25	24	24
75° 24' — 77° 52'	29	29	28	28	27	27	26	26	25	25	24
77° 52' — 80° 56'	30	29	29	28	28	27	27	26	26	25	25
80° 56' — 85° 45'	30	30	29	29	28	28	27	27	26	26	25
85° 45' — 90° 00'	31	30	30	29	29	28	28	27	27	26	26

METTLER TOLEDO

Publication Suggestion Report

If you have suggestions concerning this publication, please complete this form and fax it to (614) 841-7295

Publication Name: METTLER TOLEDO VLF Floor Scale and HAWK Terminal Service Manual

Publication Part Number: A15849100A

Publication Date: 2/01

PROBLEM(S) TYPE:	DESCRIBE PROBLEM(S):	INTERNAL USE ONLY
<input type="checkbox"/> Technical Accuracy	<input type="checkbox"/> Text <input type="checkbox"/> Illustration	
<input type="checkbox"/> Completeness What information is missing?	<input type="checkbox"/> Procedure/step <input type="checkbox"/> Illustration <input type="checkbox"/> Definition <input type="checkbox"/> Example <input type="checkbox"/> Guideline <input type="checkbox"/> Feature <input type="checkbox"/> Explanation <input type="checkbox"/> Other (please explain below)	<input type="checkbox"/> Information in manual <input type="checkbox"/> Information not in manual
<input type="checkbox"/> Clarity What is not clear?		
<input type="checkbox"/> Sequence What is not in the right order?		
<input type="checkbox"/> Other Comments Use another sheet for additional comments.		

Your Name: _____ Location: _____

Phone Number: (_____) _____

Fax this completed form to METTLER TOLEDO at (614) 841-7295

METTLER TOLEDO
1900 Polaris Parkway
Columbus, Ohio 43240 USA

P/N: A15849100A

(2/01).00

METTLER TOLEDO® is a registered trademark of Mettler-Toledo, Inc.
©1999, 2001 Mettler-Toledo, Inc.
Printed in USA



A15849100A